











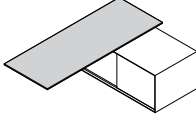
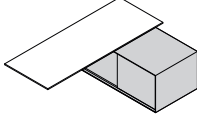



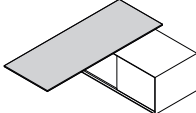
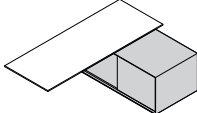

## SPECYFIKACJA TECHNICZNA KOLORYSTYKA

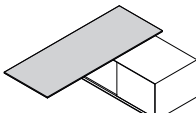
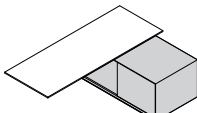
### BIURKO, STANOWISKO MULTIMEDIALNE, STÓŁ KONFERENCYJNY - BLAT, KORPUS, STELAŻ



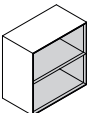
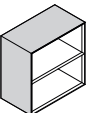

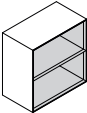
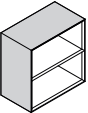

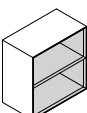
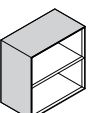
 156 WIAZ	 159 BIAŁY	 M015 BIAŁY PÓLMAT		
 157 ORZECH AMERYKAŃSKI	 158 GRAFIT	 M154 ANTRACYT PÓLMAT		
 *158 GRAFIT	 158 GRAFIT	 M154 ANTRACYT PÓLMAT		

\*UWAGA! 158 GRAFIT - Wierzch blatu pokryty laminatem nano-tech FENIX.



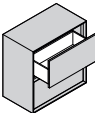
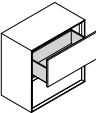

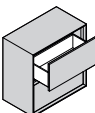
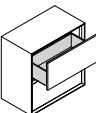
### REGAŁ - KORPUS WEWNĄTRZ, Z ZEWNĄTRZ

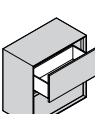
 156 WIAZ	 159 BIAŁY		
 157 ORZECH AMERYKAŃSKI	 158 GRAFIT		
 158 GRAFIT	 158 GRAFIT		

### SZAFKA - KORPUS, SZUFLADA FRONT, WNEŹRZE

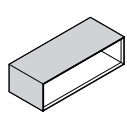
 156 WIAZ	 159 BIAŁY		
 157 ORZECH AMERYKAŃSKI	 158 GRAFIT		
 158 GRAFIT	 158 GRAFIT		

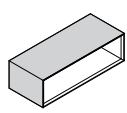
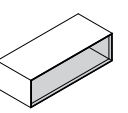
### STOLIK KAWOWY- KORPUS Z ZEWNĄTRZ, WEWNĄTRZ

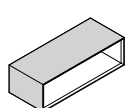
 156 WIAZ	 159 BIAŁY		
 157 ORZECH AMERYKAŃSKI	 158 GRAFIT		
 158 GRAFIT	 158 GRAFIT		

## SPECYFIKACJA TECHNICZNA

## BIURKA

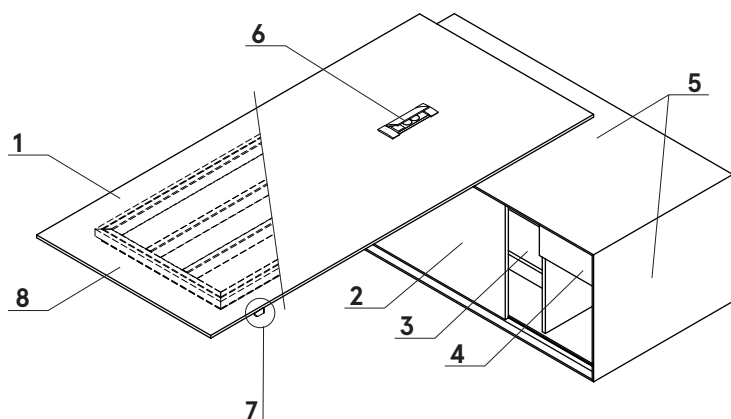

1. **Blat** - fornir/HPL, max. obciążenie 70kg
2. **Front przesuwny** - MDF lakierowany 18mm
3. **Półka** - płyta melaminowana 18mm
4. **Szublada** - pełen wysuw, samodomyk, wymiar: 500x290x280mm
5. **Korpus** - MDF lakierowany 28mm
6. **OPCJA Z DOPEŁNIĄ** - Mediabox M06 - 2x gniazdo zasilające 240V, kolor: aluminium anodowane
7. **Panel sterowania**
8. **Stelaż elektryczny** - metal malowany proszkowo, wymiary kolumny 150x150mm, profil stelaża 60x30mm

## PANEL STEROWANIA + NAPĘD

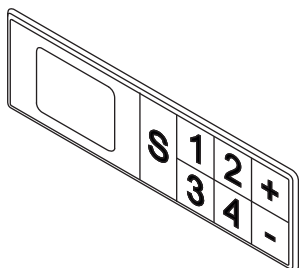

## SPECYFIKACJA TECHNICZNA STELAŻA

**Podnoszenie** - 40mm/s Super Soft - Start - Stop

**Napęd** - 2 silniki z synchronizacją, sterowane przez mikroprocesor z zabezpieczeniem przed przeciążeniem, termiczny czujnik pracy silnika

**Zabezpieczenia** - ISP -

Intelligent System Protection

**Normy** - ISO 21016, EN 527-2, EN 527-3

**Dyrektywy** - 206/95EC, UI508 1999, UL 1004 R7 06, WE DC 2004/108WE

**Zasilanie** - 230V, moc 300W, zużycie w trybie

**Stand** - by 0.3W

## WYMIARY BIURKA

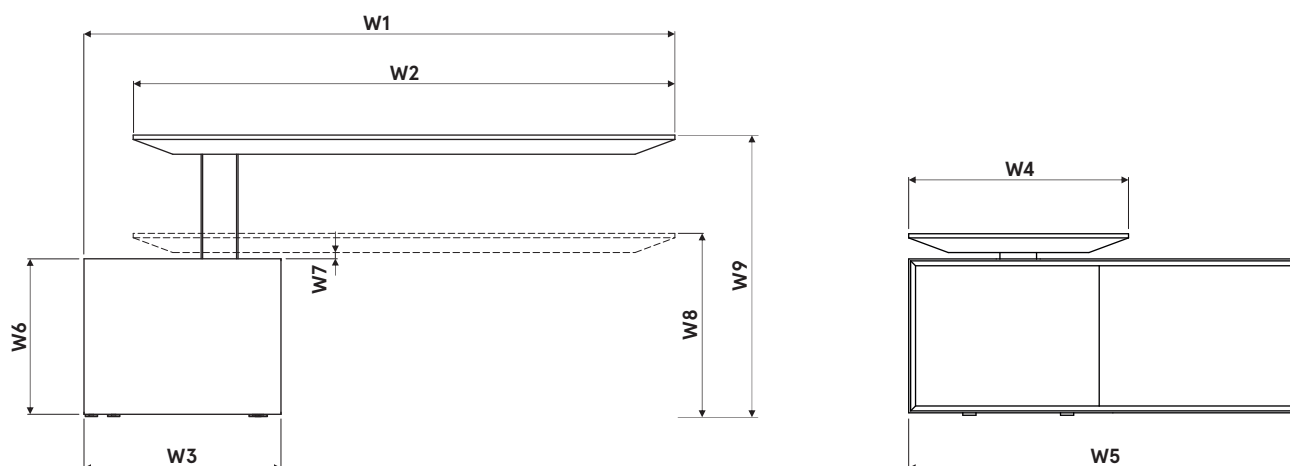

W1 - 2400mm / W2 - 2200mm / W3 - 800mm / W4 - 1000mm / W5 - 1600mm / W6 - 632mm / W7 - 25mm / W8 - 746mm / W9 - 1156mm

## SPECYFIKACJA TECHNICZNA

## STANOWISKO MULTIMEDIALNE Z ELEKTRYCZNĄ REGULACJĄ WYSOKOŚCI

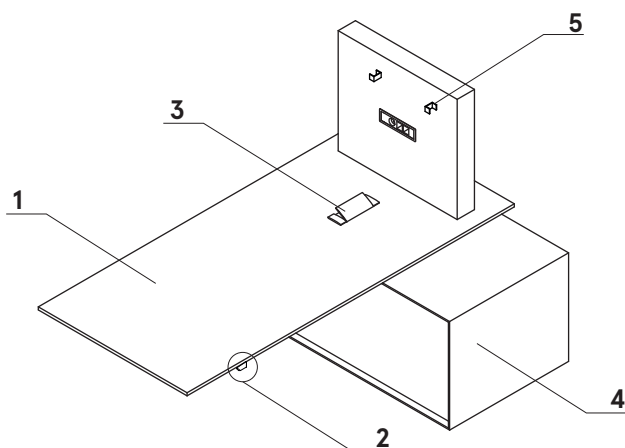

1. Blat - fornir/HPL, max. obciążenie 70kg
2. Panel sterowania
3. Mediabox M06 - 2x gniazdo zasilające 240V + 1xHDMI, kolor: aluminium anodowane
4. Korpus - MDF lakierowany 28mm
5. Uchwyt do monitora - mocowanie VESA, dla monitorów 32"-47"

## STANOWISKO MULTIMEDIALNE - WYMIARY

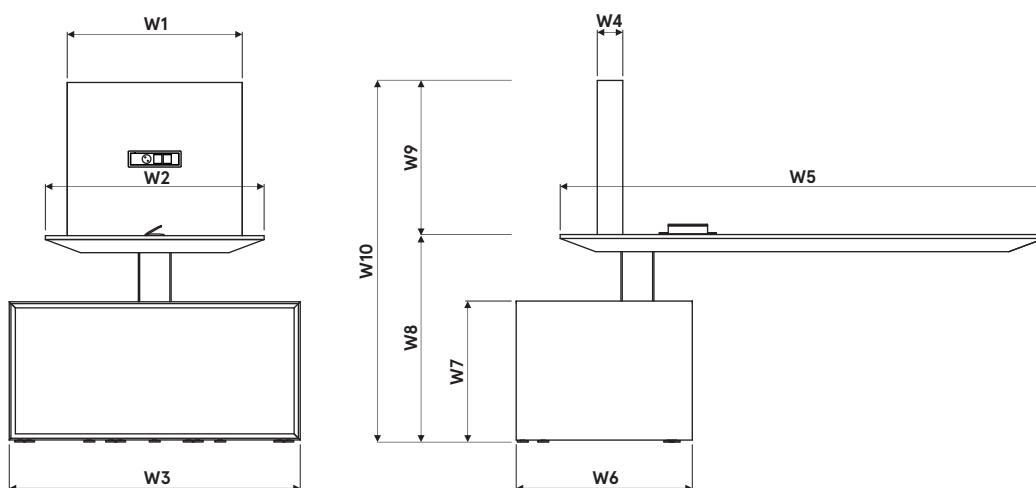

W1 - 800mm / W2 - 1000mm / W3 - 1350mm / W4 - 116mm / W5 - 2200mm / W6 - 800mm / W7 - 643mm / W8 - 946mm / W9 - 700 / W10 - 1646